



# STOKES

## Appliance Parts

# Service Manual

### Water Heating Section F

**Includes:**

Hot Water Storage Elements &  
Thermostats, Urns, Kettles and  
Jug Replacement Elements.

**Stokes Appliance Parts - National Administration Centre**

24 Palmerston Road West, Ringwood, Victoria 3134, Australia

Ph: 61 3 9872 7474 Fax: 61 3 9872 7400 Freecall: 1800 333 191

E-mail: [parts@stokes-aus.com.au](mailto:parts@stokes-aus.com.au) Web: [www.stokesap.com.au](http://www.stokesap.com.au)

There are two types of elements (heating units) used in electric hot water storage systems, bobbin elements and metal sheathed immersion elements. Mains pressure systems are fitted with metal sheathed immersion elements while vented systems may be fitted with either type.

**Bobbin elements**

Bobbin elements consist of heating element spirals wound onto ceramic bobbins. This type of element is not directly immersed in water but inserted into a removable, copper sheath screwed into the cylinder of the hot water system.

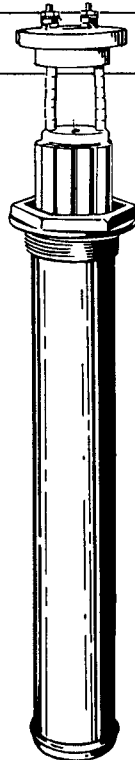

**SERVICE TIPS**

- Inspect the defective element for water stains (usually green) before fitting a replacement unit. If there are signs of leaking, replace the sheath as well.
- When replacing a sheath always loosen it when the cylinder is full of water, then drain and remove the sheath. This will avoid damage to the cylinder if the sheath is difficult to remove.
- Ensure that the active part of the element is fully inserted into the sheath.
- Replace any burnt terminal screws.
- When replacing an element in an existing sheath, clean the inside of the sheath to remove any scale or debris before fitting the new element.

**Metal sheathed immersion elements**

Metal sheathed immersion elements consist of a heating element spiral enclosed in a tubular metal sheath. Compacted magnesium oxide is used to insulate the heating element and to transfer heat to the sheath. The terminal ends of the sheath are sealed against moisture penetration. A selection of sheath materials is available to suit various water supplies. Stokes bolt-on metal sheathed immersion elements are resistance earthed to extend anode life in mains pressure systems.

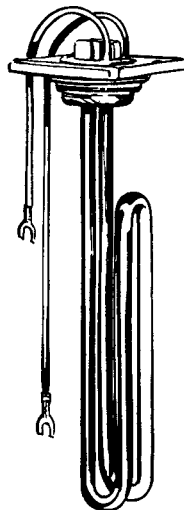

**SERVICE TIPS**

- When replacing a bolt on element make sure that the word "up" (stamped on the flange) is in the correct position.
- Remove faulty elements carefully. The folded back section of double loop shaped elements can catch and open up inside the cylinder making removal difficult and sickle shaped elements can strike and damage the anode.
- Always check the sacrificial anode in mains pressure systems and replace if it is short or cracked. This will extend the life of the element.
- When replacing a bolt on element do not overtighten the bolts on the flange as this causes the gasket to extrude and leaking can occur.

**Element configurations**

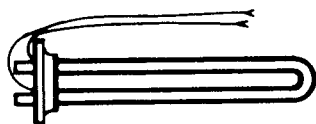

SINGLE LOOP (SL)

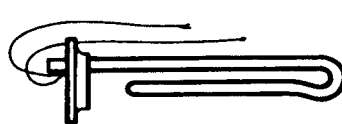

DOUBLE LOOP (DL)

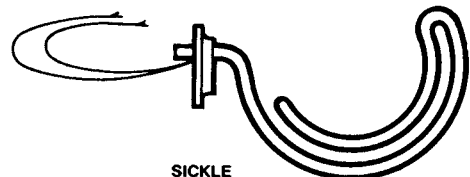

SICKLE

Most electric hot water storage systems in Australia consist of a well insulated cylinder fitted with a heating element and thermostat. Cold water is fed into the bottom of the cylinder where it is heated by the element to a preset temperature which is thermostatically maintained. The heated water, being less dense than cold water, rises to the top of the cylinder where it is drawn off for use.

## 1. Mains pressure (unvented) hot water system

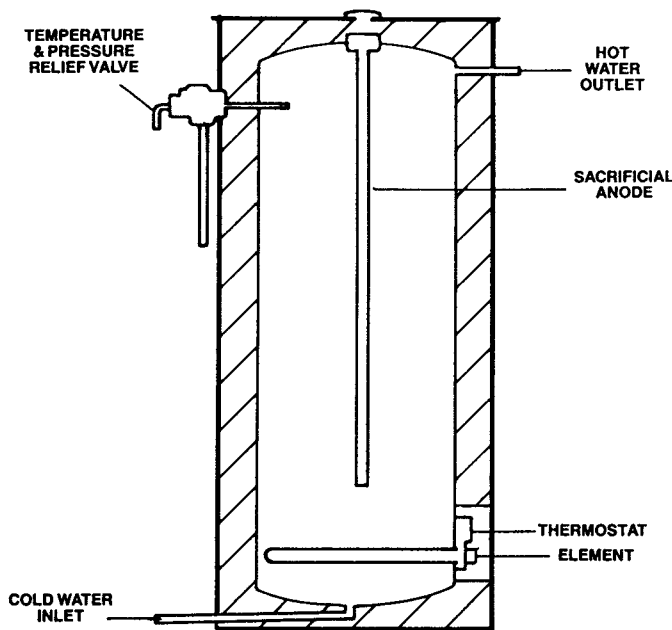

The most popular system in Australia today is the mains pressure (unvented) system which is connected directly to the mains cold water supply and delivers the heated water at mains pressure.

A temperature and pressure relief valve is fitted to automatically discharge water in the event of excessive pressure.

The inner cylinder is made of mild steel lined with vitreous enamel (glass) or nylon (riisan). Corrosion by electrolysis is retarded by the use of a sacrificial anode.

## 2. Gravity fed (vented) hot water system – feed tank attached

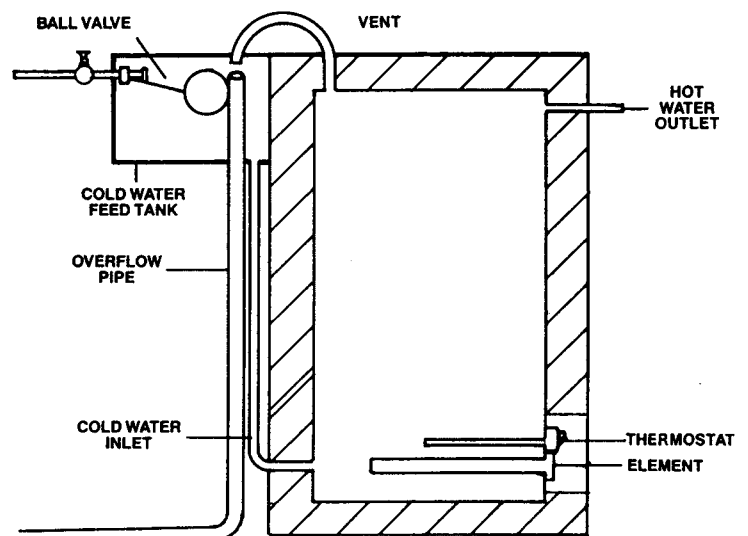

Vented or gravity fed systems are still widely used in Australia but have lost popularity in recent times. These systems utilize a cold water feed tank, either as a separate unit located above the cylinder or attached to the cylinder. Excessive temperature and pressure caused by water expansion during heating is prevented by means of a vent which provides a permanently open air passage. The inner cylinder is usually made of copper.

**Bolt-on Elements**

**High Corrosion Resistant Incoloy 825 Sheath**

These elements have been designed for use in hard water areas. The sheath material, Incoloy 825, is an alloy which was developed to meet severe corrosive conditions. Where practical, a lower watts density has also been used to give an increased heated surface area for additional protection from corrosion.

New Cat No.	Superseded Cat No.	Type	Wattage	Watts Density (kW/m <sup>2</sup> )	Penetration Length (mm)
2511XN	2511X	DL	2400	93	305
3480XN	3480X	DL	4800	164	432
3481XSN	3481XS	Sickle	1800	82	305
3428XSN	3428XS	Sickle	3000	93	305
3482XSN	3482XS	Sickle	3600	93	292
3480XSN	3480XS	Sickle	4800	164	305
1264-21		Sealing Gasket			

**Corrosion Resistant Incoloy 800 Sheath**

New Cat No.	Superseded Cat No.	Type	Wattage	Watts Density (kW/m <sup>2</sup> )	Penetration Length (mm)
1327XN	1327X	DL	1800	120	220
1329XN	1329X	DL	2400	120	305
1330XN	1330X	DL	3000	120	305
1331XN	1331X	DL	3600	120	330
1329XSN	1329XS	Sickle	2400	120	279
1330XSN	1330XS	Sickle	3000	120	279
1331XSN	1331XS	Sickle	3600	120	305
1321XSN	1321XS	Sickle	4800	120	305
1264-21		Sealing Gasket			

**Tin Plated Copper Sheath**

New Cat No.	Superseded Cat No.	Type	Wattage	Watts Density (kW/m <sup>2</sup> )	Penetration Length (mm)
9381XN	9381X	DL	750	70	127
1336XN	1336X	SL	1200	120	279
1337XN	1337X	DL	1500	120	305
3662	1338X	DL	1800	120	230
1339XN	1339X	DL	2000	120	254
1340XN	1340X	DL	2400	120	305
3664	1264X	DL/Offset	3000	120	305
3665	1265X	DL/Offset	3600	120	355
3666	1343XS	DL/Offset	4800	120	305
1303XSN	1303XS	Sickle	1500	39	305
1340XSN	1340XS	Sickle	2400	120	279
1264XSN	1264XS	Sickle	3000	120	279
1265XSN	1265XS	Sickle	3600	120	305
9616XSN	9616	Sickle	6000	120	375
1264-21		Sealing Gasket			

**Booster Elements**

High watts density elements with corrosion resistant Incoloy 800 sheath

New Cat No.	Superseded Cat No.	Type	Wattage	Watts Density (kW/m <sup>2</sup> )	Penetration Length (mm)
2519XN	2519X	DL	2400	190	203
2520XN	2520X	DL	3600	190	203
1264-21		Sealing Gasket			

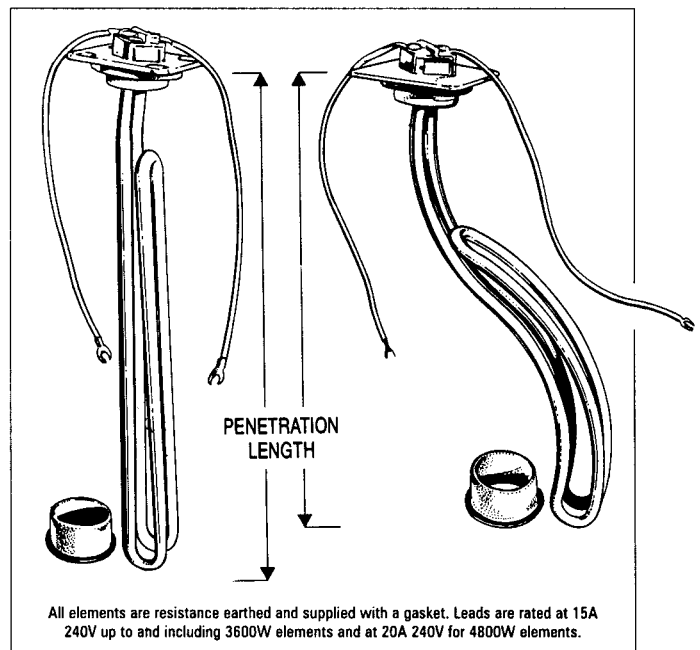

**Braemar – used in “Rilsan” Type Hot Water Systems**

Corrosion resistant Incoloy 800 sheath. Element is angled away from the mount plate to sit very low in the cylinder. A robust gasket (8mm thickness) is supplied with the element.

**Note:** Standard bolt-on elements must not be used to replace this series.

Cat No.	Type	Wattage	Watts Density (kW/m <sup>2</sup> )	Penetration Length (mm)
2504	Sickle	1200	120	285
2505	Sickle	1500	120	285
2506	Sickle	1800	120	285
2507	Sickle	2400	120	285
2508	Sickle	3000	120	285
2509	Sickle	3600	120	285
2510	Sickle	4800	120	285
2504-01		Sealing Gasket		

**Please note** that the Braemar type elements above are being phased out and will eventually become N.L.A.

**Copper Sheath Offset**

Cat No.	Type	Wattage	Watts Density (kW/m <sup>2</sup> )	Penetration Length (mm)
3662	DL/Offset	1800	120	230
3663	DL/Offset	2400	120	260
3664	DL/Offset	3000	120	295
3665	DL/Offset	3600	120	350
3666	DL/Offset	4800	120	380
1264-21		Sealing Gasket		

**NOTE:**  
Sacrificial Anodes and P.T.R. Valves are now available from Stokes and are featured in this section.

## Screw-in Elements

### 1" B.S.P. High Corrosion Resistant Incoloy 825 Sheath

Cat No.	Type	Wattage	Watts Density (kW/m <sup>2</sup> )	Penetration Length (mm)
2512BL	DL	2400	90	305
1094-28	Sealing Gasket			

### 1" B.S.P. Corrosion Resist. Incoloy 800 Sheath

Cat No.	Type	Wattage	Watts Density (kW/m <sup>2</sup> )	Penetration Length (mm)
1323BL	SL	600	120	184
1324BL	SL	900	120	215
1325BL	DL	1200	120	254
1326BL	DL	1500	120	203
1327BL	DL	1800	120	229
1328BL	DL	2000	120	215
1329BL	DL	2400	120	292
1330BL	DL	3000	120	305
1331BL	DL	3600	120	317
1332BL	DL	3600	140	298
1333BL	DL	4800	140	393
1094-28	Sealing Gasket			

### 1" B.S.P. Tin Plated Copper Sheath

Cat No.	Type	Wattage	Watts Density (kW/m <sup>2</sup> )	Penetration Length (mm)
9382BL	DL	750	104	102
1334BL	SL	600	120	165
1335BL	SL	900	120	228
1336BL	SL	1200	120	254
1337BL	SL	1500	120	190
1338BL	DL	1800	120	228
1339BL	DL	2000	120	254
1340BL	DL	2400	120	292
1169BL	DL	3000	230	203
1264BL	DL	3000	120	305
1341BL	DL	3600	140	305
1094BL	DL	3600	230	203
1265BL	DL	3600	120	342
1342BL	DL	4800	140	406
1126BL	DL	4800	230	305
1094-28	Sealing Gasket			

### 1 1/4" B.S.P. Corrosion Resist. Incoloy 800 Sheath

Cat No.	Type	Wattage	Watts Density (kW/m <sup>2</sup> )	Penetration Length (mm)
2225-125R	DL	1800	120	203
2226-125R	DL	2000	120	220
2227-125R	DL	2400	120	255
2228-125R	DL	3000	120	305
2229-125R	DL	3600	120	355
2230-125R	DL	4800	120	455
2219R	Terminal cover and stud assembly			

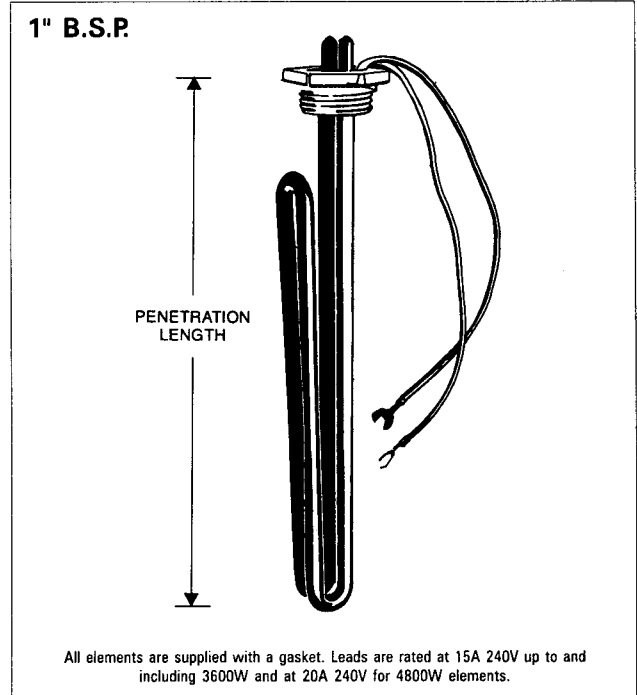

### 2" B.S.P. Corrosion Resist. Incoloy 800 Sheath

Cat No.	Type	Wattage	Watts Density (kW/m <sup>2</sup> )	Penetration Length (mm)
2225-200R	DL	1800	120	203
2226-200R	DL	2000	120	220
2227-200R	DL	2400	120	255
2228-200R	DL	3000	120	305
2229-200R	DL	3600	120	355
2230-200R	DL	4800	120	455
2220R	Terminal cover and stud assembly			

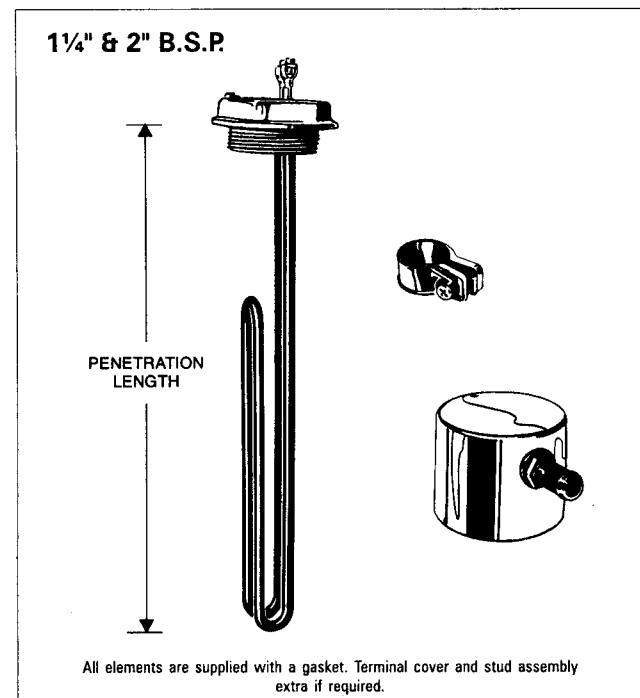

**Bobbin Elements**

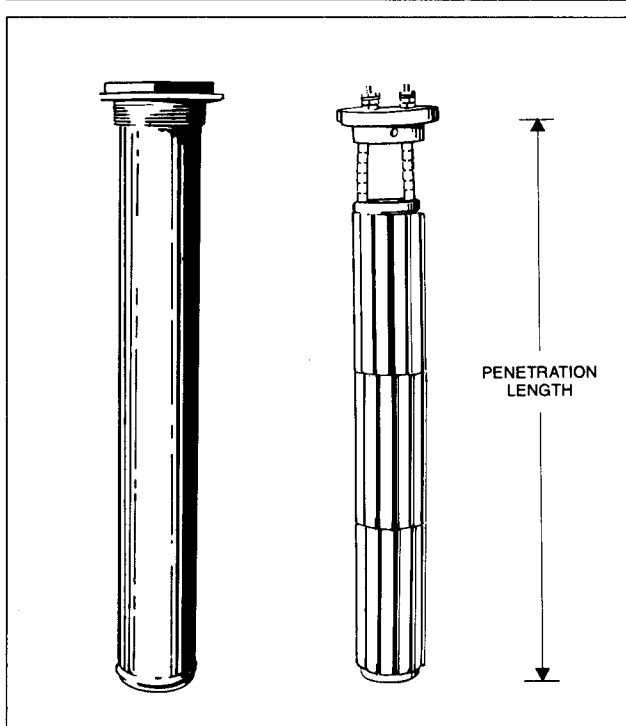

**2" Bobbin Elements**

Cat No.	Wattage	Penetration Length (mm)	Copper Sheath (Cat No.)
B	4800	525	9188
B1	3600	500	9188
B2	3000	500	9188
B3	2400	370	9187
B4	2000	370	9187
B5	1800	370	9187
B6	1500	320	9186
B7	1200	220	9185
B8	1000	220	9185
B9	750	220	9185

**1 1/4" Bobbin Elements**

To suit Braemar and Langco sink heaters

Cat No.	Wattage	Penetration Length (mm)	Copper Sheath (Cat No.)
B10	750	270	9186

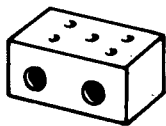

**Cat No. 2300-06**  
**CERAMIC 2 WAY**  
**CONNECTOR 15 amp**  
30mm x 15mm x 20mm  
Also available:  
**2300-15** 15 amp  
**2300-30** 30 amp

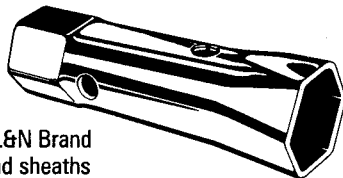

**Cat No. SELS3**  
**TUBE SPANNER**

To suit most 1", 1 1/4" & 2" L&N Brand water heating elements and sheaths

**1 5/8" Bobbin Elements**

South Australian Application (eg Beasley)

Cat No.	Wattage	Penetration Length (mm)	Copper Sheath (Cat No.)
B1A	3300	500	9188
B2A	2750	350	9187
B3A	2400	470	9187
B4A	2750	500	9188
B5A	1800	370	9187
B6A	1500	320	9186
B8A	1000	220	9185
B9A	750	220	9185

**NOTE:** Special size and wattage Bobbins can be made to order.

**EQUIVALENTS LIST**

BOBBIN ELEMENTS		
LN Products	Stokes	Description
BE7	B9	750W 2" BOBBIN
BE10	B8	1000W 2" BOBBIN
BE12	B7	1200W 2" BOBBIN
BE15	B6	1500W 2" BOBBIN
BE18	B5	1800W 2" BOBBIN
BE20	B4	2000W 2" BOBBIN
BE24	B3	2400W 2" BOBBIN
BE30	B2	3000W 2" BOBBIN
BE36	B1	3600W 2" BOBBIN
BE48	B	4800W 2" BOBBIN
BES700	B9A	750W 1 5/8" BOBBIN
BES701	B8A	1000W 1 5/8" BOBBIN
BES703	B4A	2750W 1 5/8" BOBBIN
BES704	B1A	3300W 1 5/8" BOBBIN
BES705	B2A	2750W 1 5/8" BOBBIN
BES708	B6A	1500W 1 5/8" BOBBIN
BES710	B5A	1800W 1 5/8" BOBBIN
BES712	B3A	2400W 1 5/8" BOBBIN
HBH7	B10	750W 1 1/4" BOBBIN

BOBBIN ELEMENTS		
Email Grimwood	Stokes	Description
B1A	B1A	3300W 1 5/8" BOBBIN
B2A	B2A	2750W 1 5/8" BOBBIN
B4A	B4A	2750W 1 5/8" BOBBIN
4026	B10	750W 1 1/4" BOBBIN
5002	B8	1000W 2" BOBBIN
5003	B7	1200W 2" BOBBIN
5004	B6	1500W 2" BOBBIN
5005	B5	1800W 2" BOBBIN
5006	B4	2000W 2" BOBBIN
5007	B3	2400W 2" BOBBIN
5008	B2	3000W 2" BOBBIN
5009	B1	3600W 2" BOBBIN
5010	B	4800W 2" BOBBIN

BOLT-ON ELEMENTS			
Hermetic	New Cat No.	Stokes	Description
1849	1336XN	1336	1200W SL
1850	3662	1338X	1800W DL
1851	3663	1340X	2400 DL
1852	3664	1264X	3000W DL
1853	3665	1265X	3600W DL
1854	1340XSN	1340XS	2400W SICKLE
1855	1264XSN	1264XS	3000W SICKLE
1856	1265XSN	1265XS	3600W SICKLE
1857	3666	1343XS	4800W SICKLE
1858	1327XN	1327X	1800W DL
1859	1329XN	1329X	2400W DL
1860	1330XN	1330X	3000W DL
1861	1331XN	1331X	3600W DL
1862	1329XSN	1329XS	2400W SICKLE
1863	1330XSN	1330XS	3000W SICKLE
1864	1331XSN	1331XS	3600W SICKLE
1865	1321XSN	1321XS	4800W SICKLE

## Equivalents List

### EQUIVALENTS LIST

BOLT-ON ELEMENTS			
Email Grimwood	New Cat No.	Old Stokes	Description
KH89A000	1336XN	1336X	1200W SL
KH89C000	3662	1338X	1800W DL
KH98D0	3663	1340XS	2400W SICKLE
KH89E0	3664	1264XS	3000W SICKLE
KH90B000	3662	1340XS	2400W SICKLE
KH90C000	1264XSN	1264XS	3000W SICKLE
KH90D000	1265XSN	1265XS	3000W SICKLE
KH90E000	3666	1343XS	4800W SICKLE
KJ78G000	3663	1340X	2400W DL
KJ78H000	3664	1264X	3000W DL
KJ78J000	3665	1265X	3600W DL
KJ79A000	3666	1343XS	4800W SICKLE
SS18FB	1327XN	1327X	1800W DL
SS24FB	1329XN	1329X	2400W DL
SS24SI	1329XSN	1329XS	2400W SICKLE
SS30FB	1330XN	1330X	3000W DL
SS30SI	1330XSN	1330XS	3000W SICKLE
SS36FB	1331XN	1331X	3600W DL
SS36SI	1331XSN	1331XS	3600W SICKLE
SS48SI	1321XSN	1321XS	4800W SICKLE
90377AG2-4	2519XN	2519X	2400W DL
90377AG3-6	2520XN	2520X	3600W DL
3411724XR	3663	1340X	2400W DL
3411730XR	3664	1264X	3000W DL
3411736XR	3665	1265X	3600W DL
341248XR	3666	1343XS	4800W SICKLE
3440724CR	1329XN	1329X	2400W DL
3440730CR	1330XN	1330X	3000W DL
3440736CR	1331XN	1331X	3600W DL
3477AG724	1329XSN	1329XS	2400W SICKLE
3477AG730	1330XSN	1330XS	3000W SICKLE
3477AG736	1331XSN	1331XS	3600W SICKLE
3477AG748	1321XSN	1321XS	4800W SICKLE
3477CG724	1340XSN	1340XS	2400W SICKLE
3477AG730	1264XSN	1264XS	3000W SICKLE
3477CG736	1265XSN	1265XS	3600W SICKLE

LN Products	New Cat No.	Old Stokes	Description
RB18	3662	1327X	1800W DL
RB24	3663	1340X	2400W DL
RB30	3664	1264X	3000W DL
RB36	3665	1265X	3600W DL
RBM18	1327XN	1327X	1800W DL
RBM24	1329XN	1329X	2400W DL
RBM30	1330XN	1330X	3000W DL
RBM36	1331XN	1331X	3600W DL
RC24	1340XSN	1340XS	2400W SICKLE
RC30	1264XSN	1264XS	3000W SICKLE
RC36	1265XSN	1265XS	3600W SICKLE
RCM24	1329XSN	1329XS	2400W SICKLE
RCM30	1330XSN	1330XS	3000W SICKLE
RCM36	1331XSN	1331XS	3600W SICKLE
RCM48	1321XSN	1321XS	4800W SICKLE

1" B.S.P. ELEMENTS		
Email Grimwood	Stokes	Description
3252CG730	1169BL	3000W DL
3252CG736	1094BL	3600W DL
3252CG748	1126BL	4800W DL
3267AG609	1324BL	900W SL
3267AG612	1325BL	1200W DL
3267AG615	1326BL	1500W DL
3267AG718	1327BL	1800W DL
3267AG720	1328BL	2000W DL
3267AG724	1329BL	2400W DL
3267AG730	1330BL	3000W DL
3267AG736	1331BL	3600W DL
3267CG609	1335BL	900W SL
3267CG612	1336BL	1200W SL
3267CG615	1337BL	1500W SL
3267CG718	1338BL	1800W DL
3267CG720	1339BL	2000W DL
3267CG724	1340BL	2400W DL
3267CG730	1264BL	3000W DL
3267CG736	1265BL	3600W DL
3267CG748	1342BL	4800W DL
90706AG	1332BL	3600W DL
90706C	1341BL	3600W DL
90865AG	1333BL	4800W DL

LN Products	Stokes	Description
RHC6	1323BL	600W SL
RHC9	1342BL	900W SL
RHC12	1325BL	1200W DL
RHC15	1326BL	1500W DL
RHC18	1338BL	1800W DL
RHC24	1340BL	2400W DL
RHC30	1264BL	3000W DL
RHC36	1265BL	3600W DL
RHC36A	1094BL	3600W DL
RHC48	1342BL	4800W DL
RHM9	1324BL	900W SL
RHM12	1325BL	1200W DL
RHM15	1326BL	1500W DL
RHM18	1327BL	1800W DL
RHM20	1328BL	2000W DL
RHM24	1329BL	2400W DL
RHM30	1330BL	3000W DL
RHM36	1332BL	3600W DL
RHM48	1333BL	4800W DL

2" B.S.P. ELEMENTS		
Email Grimwood	Stokes	Description
3040AG610	2225-200R	1800W DL
3040AG715	2227-200R	2400W DL
3040AG718	2228-200R	3000W DL
3040AG719	2229-200R	3600W DL
3040AG721	2230-200R	4800W DL

LN Products	Stokes	Description
SX18	2225-200R	1800W DL
SX20	2226-200R	2000W DL
SX24	2227-200R	2400W DL
SX30	2228-200R	3000W DL
SX36	2229-200R	3600W DL
SXM18	2225-200R	1800W DL
SXM20	2226-200R	2000W DL
SXM24	2227-200R	2400W DL
SXM30	2228-200R	3000W DL
SXM36	2229-200R	3600W DL

1 1/4" B.S.P. ELEMENTS		
Email Grimwood	Stokes	Description
3039AG610	2225-125R	1800W DL
3039AG715	2227-125R	2400W DL
3039AG715	2227-125R	2400W DL
3039AG718	2228-125R	3000W DL
3039AG719	2229-125R	3600W DL

LN Products	Stokes	Description
S18	2225-125R	1800W DL
S20	2226-125R	2000W DL
S24	2227-125R	2400W DL
S30	2228-125R	3000W DL
S36	2229-125R	3600W DL
SM18	2225-125R	1800W DL
SM20	2226-125R	2000W DL
SM24	2227-125R	2400W DL
SM30	2228-125R	3000W DL
SM36	2229-125R	3600W DL

Thermostats

Thermostats automatically maintain a pre-determined temperature by controlling the supply of energy to the element. The types of thermostats usually fitted to electric hot water storage systems are stem type (immersion) thermostats and surface mounted (contact) thermostats. Temperature settings may be either fixed or adjustable.

Mains pressure and unvented systems are also fitted with an over temperature energy cut out (E.C.O.). This is a safety device used to cut off the supply of energy to the element if the thermostat fails and water temperature exceeds its set temperature. E.C.O.'s operate independently of the thermostat but may share the same mounting facilities or be incorporated with the thermostat eg. Cat Nos. W1M2/80 and 6043.

**Non-Simultaneous Dual Element Operation**

Some electric hot water storage systems are fitted with an additional element to serve as a booster. This element has its own thermostat and is located at the top of the cylinder where water is drawn off for use.

As the elements are on separate circuits, they are usually wired for non-simultaneous operation to avoid excessive current demand after a large draw off of hot water.

The booster element has priority, only allowing the main element to operate when the water in the upper part of the cylinder reaches set temperature and its thermostat cuts out.

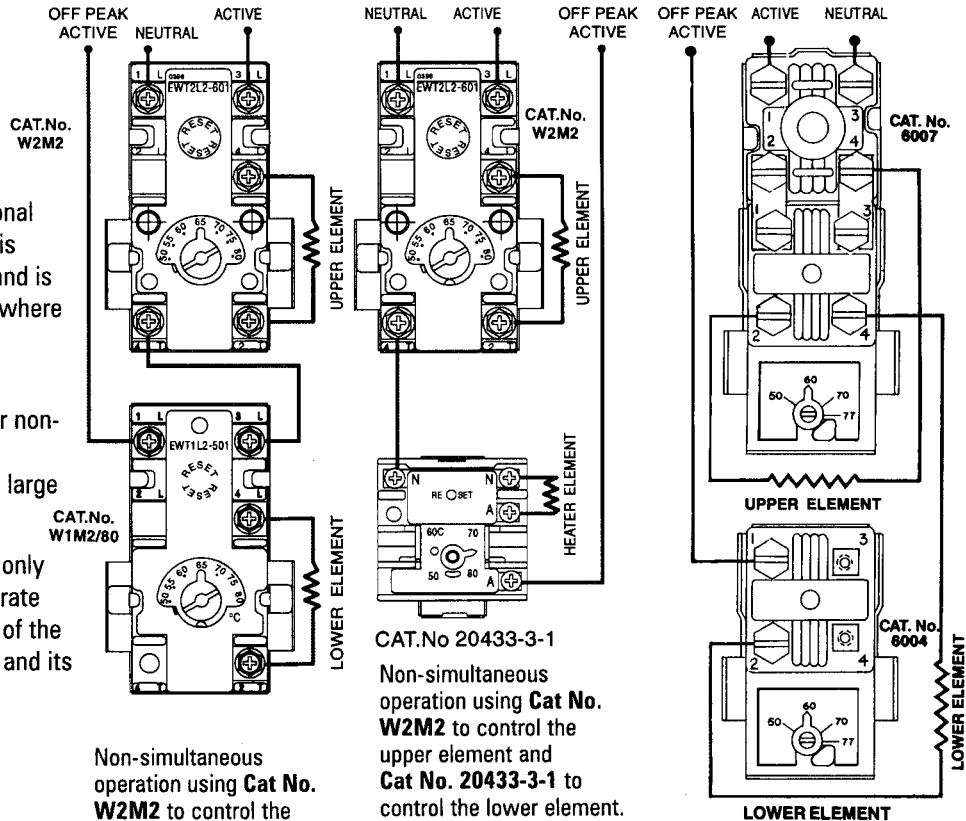

Non-simultaneous operation using **Cat No. W2M2** to control the upper element and **Cat No. W1M2/80** to control the lower element. Both thermostats incorporate an E.C.O.

**CAT.No 20433-3-1**  
Non-simultaneous operation using **Cat No. W2M2** to control the upper element and **Cat No. 20433-3-1** to control the lower element. Both thermostats incorporate an E.C.O.

Non-simultaneous operation using 2 X **Cat No. 6004** to control the elements and **Cat No. 6007** as the E.C.O.

**Single Element Operation**

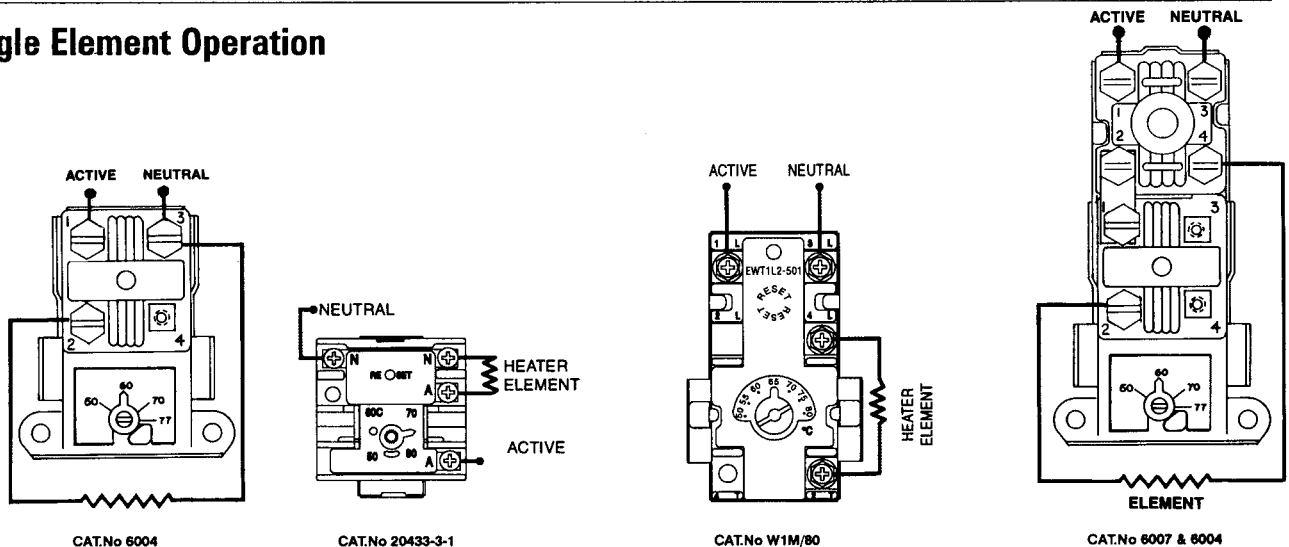

CAT.No 6004

CAT.No 20433-3-1

CAT.No W1M/80

CAT.No 6007 & 6004



## Surface Mounted Thermostats – THERM-O-DISC

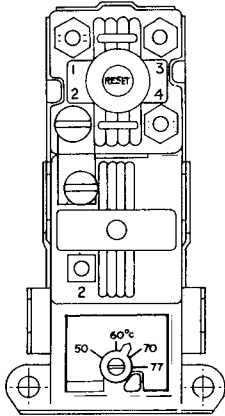

**Cat No. 6001**  
Combination adjustable thermostat S.P.S.T.  
Temp. range: 50-77°C  
Differential: 3-8°C  
Type: AW/HLC  
Manual reset E.C.O.  
D.P.S.T. set at 88°C  
Electrical rating: 25A

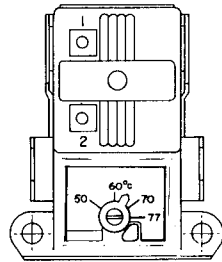

**Cat No. 6002**  
Adjustable thermostat S.P.S.T.  
Temp. range: 50-77°C  
Differential: 3-8°C  
Type: AW7030  
Electrical rating: 25A

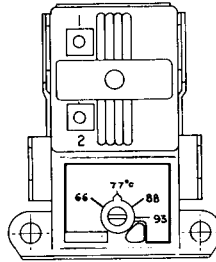

**Cat No. 6003**  
Adjustable thermostat S.P.S.T.  
Temp. range: 66-93°C  
Differential: 3-8°C  
Type: AW8052  
Electrical rating: 25A

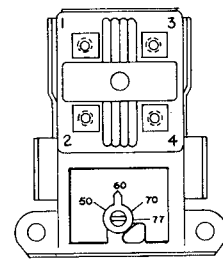

**Cat No. 6004**  
Adjustable thermostat D.P.S.T.  
Temp. range: 50-77°C  
(Adjustable stop set at 60°C)  
Differential: 9-15°C  
Type: AW7140  
Electrical rating: 25A

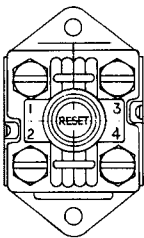

**Cat No. 6005**  
Energy cut out set at 104°C ± 3°C  
Manual reset D.P.S.T.  
Type: HLM1906  
Electrical rating: 40A  
(Can be independently mounted)

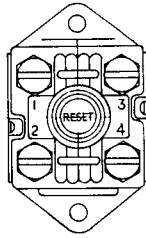

**Cat No. 6006**  
Energy cut out set at 88°C ± 3°C  
Manual reset D.P.S.T.  
Type: HLM1907  
Electrical rating: 40A  
(Can be independently mounted)

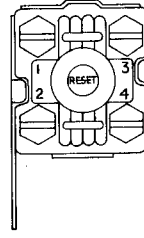

**Cat No. 6007**  
Energy cut out set at 88°C ± 3°C  
Manual reset D.P.S.T.  
Type: HLC1908  
Electrical rating: 40A  
(Can be independently mounted)

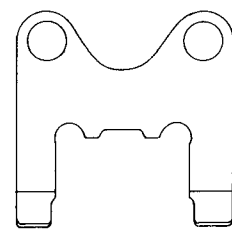

**Cat No. 6008**  
Clamp bracket for use with Cat. Nos. 6001 & 6043. Also where a combination of two thermostats are used eg. Cat Nos. 6004 & 6007

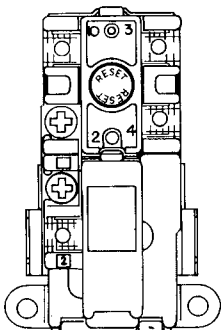

**Cat No. 6012**  
Combination thermostat S.P.S.T.  
Temperature fixed at 65°C  
Differential: 3-8°C  
Type: 59T/66T  
Manual reset E.C.O.  
set at 88°C  
Electrical rating: 30A

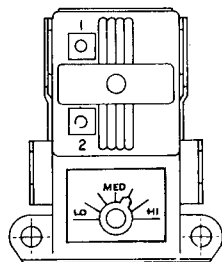

**Cat No. 6041**  
Adjustable thermostat S.P.S.T.  
Temperature range: 50-77°C  
Marked lo-med-hi  
Differential: 3-8°C  
Type: AW7062  
Electrical rating: 30A

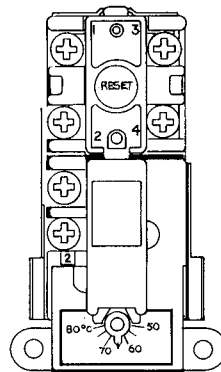

**Cat No. 6043**  
Combination adjustable thermostat S.P.S.T.  
Temperature range: 50-80°C  
Differential: 3-8°C  
Type: 59T/66T  
Manual reset E.C.O. set at 88°C  
Electrical rating: 30A

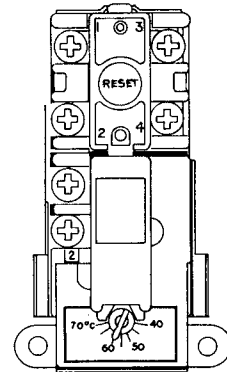

**Cat No. 6053**  
Combination adjustable thermostat S.P.S.T.  
Temperature range: 40-70°C  
Differential: 3-8°C  
Type: 59T/66T  
Manual reset E.C.O. set at 88°C  
Electrical rating: 30A

Surface Mounted Thermostats – **ROBERTSHAW**

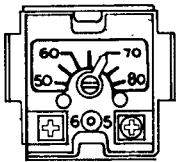

**Cat No. W1**  
Adjustable thermostat S.P.S.T.  
Temp. range: 50-80°C  
Differential:  $\pm 5^\circ\text{C}$   
Electrical rating: 25A

**Cat No. W1/93**  
Adjustable thermostat S.P.S.T.  
Temp. range: 63-93°C  
Differential:  $\pm 5^\circ\text{C}$   
Electrical rating: 25A  
(Dairy applications)

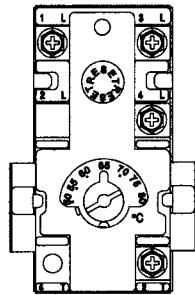

**Cat No. W1M2/70**  
Combination adjustable thermostat S.P.S.T.  
Temp. range: 50-80°C with stop at 70°C  
Differential:  $8^\circ\text{C} \pm 4^\circ\text{C}$   
Manual reset E.C.O. D.P.S.T. with 86°C as standard setting  
Electrical rating: 30A

**Cat No. W1M2/80**  
Combination adjustable thermostat S.P.S.T.  
Temp. range: 50-80°C  
Differential:  $8^\circ\text{C} \pm 4^\circ\text{C}$   
Manual reset E.C.O. D.P.S.T. with 88°C as standard setting  
Electrical rating: 30A

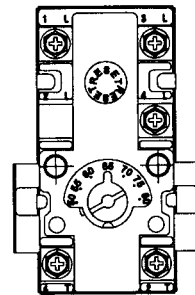

**Cat No. W2M2**  
Combination adjustable thermostat S.P.D.T.  
Temp. range: 50-80°C  
Differential:  $15^\circ\text{C} \pm 3^\circ\text{C}$   
Manual reset E.C.O. D.P.S.T. with 94°C as standard setting  
Electrical rating: 25A

**SOLAHART**

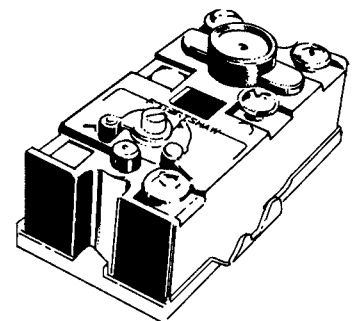

**Cat No. W1M2519**  
Combination adjustable thermostat S.P.S.T.  
Temp. range: 50-80°C  
Differential:  $\pm 5^\circ\text{C}$   
Manual reset E.C.O. D.P.S.T. with 92°C as standard setting  
Electrical rating: 25A with centre mount hole for mounting.

## Surface Mounted Thermostats –

### KLIXON

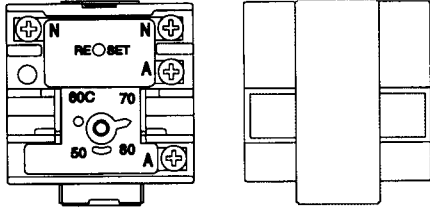

**Cat No. 20433-3-1**  
 Combination adjustable thermostat S.P.S.T.  
 Factory set at 70°C  
 Differential: 10°C  
 Manual reset E.C.O. D.P.S.T. set at 90°C  
 Electrical rating: 30A  
 Replaces old Part Numbers 20431-3  
 and DY399-33

### DERWENT

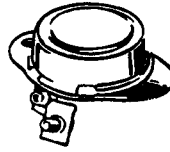

**Cat. No TE-170**  
 Thermostat S.P.S.T.  
 Temperature set at 77°C  
 Electrical rating: 25A

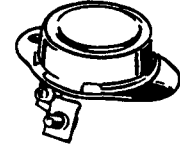

**Cat No. TE-205**  
 Thermostat  
 Temperature set at 96°C  
 Electrical rating: 25A  
 (Dairy applications)

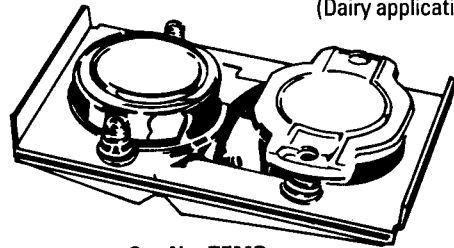

**Cat No. TEMP**  
 Combination thermostat  
 Temperature set at 77°C  
 Manual E.C.O. set at 90°C  
 Electrical rating: 25A

## Stem Type Thermostats – ELECTRIC

These units will replace various stem type thermostats including Satchwell, Turnerstat, Thermion, Thermowatt, Actrol and Proscon.  
 Switching: S.P.S.T. Electrical rating: 20 amp

Cat No.	Reset	Insertion Probe Diam x Length	Temperature Range	Sheath to Suit	Dif °C
TES/11	Manual	6mm x 280mm	0-80°C Eco 92°C	S/11	8
TES/7	Manual	6mm x 178mm	0-80°C Eco 92°C	S/7	10
TE/11	Auto	6mm x 280mm	0-80°C	S/11	8
TE/7	Auto	6mm x 178mm	0-80°C	S/7	10
*TE/D	Auto	6mm x 280mm	0-100°C	S/11	8

\*Dairy applications

Sheaths are 1/2" BSP mounting

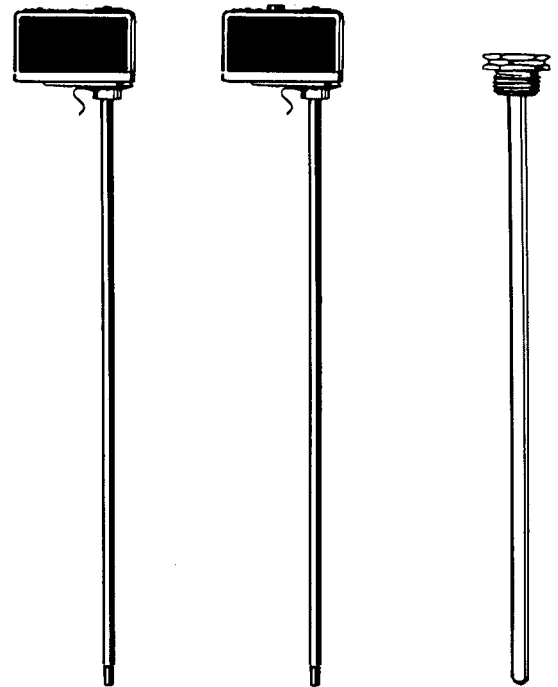

TE/7

TES/7

S/7

## Stem Type Thermostats – GAS (see gas section in this manual)

Sacrificial Anodes

**INCREASE THE LIFE . . .**

**of your MAINS PRESSURE HOT WATER HEATERS  
through regular replacement of their  
SACRIFICIAL ANODES . . .**

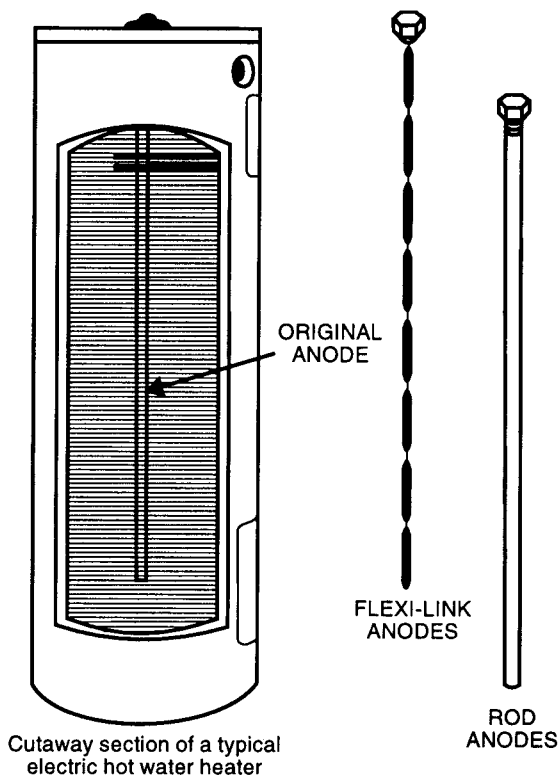

Cutaway section of a typical electric hot water heater

**Use the same guaranteed method that the manufacturers use to protect their interest during the warranty period!**

Every brand of mains pressure storage heater with vitreous enamel (glass) lined tanks is fitted with between one and three anodes to ensure corrosion cannot take place during the warranty period.

These can last for as little as 2-3 years being expended and thus allowing corrosion to commence.

**GAS, ELECTRIC OR SOLAR HEATERS**

By simply replacing your anodes every 2-3 years (or as required) you provide the same protection that keeps ships afloat, underground steel pipelines and tanks corrosion free and the World's sea based oil drilling platforms intact.

**ANO-GUARD SACRIFICIAL ANODES**

**Offer a range of 15 rigid and flexible anodes to suit Gas or Electric glass lined mains pressure hot water heaters and Solar heaters.**

**ANO-GUARD SACRIFICIAL ANODES**

Offer the choice of replacement with the original type "Rod" anodes OR if access space is a problem, their exclusive "FLEXI-ROD" flexible anodes. "ALUMINIUM" anodes could be selected in older heaters where the previous anode has ceased to operate for some time particularly in areas of "harder" water to ensure that "gassing" is not experienced.

**PLEASE TURN OVER FOR SELECTION GUIDE**

## Sacrificial Anodes

### ANODE SELECTION GUIDE

<b>"ROD TYPE"</b>	Cat. No. ANR810	Cat. No. ANR1210	Cat. No. ANR1510	Cat. No. ANR1686
<b>"FLEXI ROD" TYPE</b>	Cat. No. ANR810F	Cat. No. ANR1210F	Cat. No. ANR1510F	Cat. No. ANR1686F
<b>"ALUMINIUM TYPE"</b>	Cat. No. ANL1177 (cut to size)	Cat. No. ANL1177	Cat. No. ANL1424	Cat. No. ANL1686
<b>ALL USED ON</b>				
<b>ELECTRIC</b>				
RHEEM	80 litre	125 litre 250 litre	160 litre 315 litre	400 litre
HARDIE DUX	80 litre 125 litre	160 litre 250 litre	315 litre 400 litre	
VULCAN	80 litre 125 litre	250 litre	160 litre 315 litre	400 litre
BEASLEY		135 litre	170 litre 270 litre	400 litre 315 litre
<b>GAS</b>				
RHEEM	90 litre	135 litre 200 litre 260 litre 290 litre	170 litre	
HARDIE DUX	90 litre	135 litre	170 litre	
VULCAN 'HOTSHOT'	90 litre	135 litre		
VULCAN 'FREELoader'		120 litre 145 litre	185 litre	
BEASLEY	90 litre	135 litre 200 litre 260 litre	170 litre	

<b>"SOLAR TYPE"</b>	Cat No. ANS1655	Cat No. ANS2082 34mm NUT	Cat No. ANS2082A 43mm NUT
<b>USED ON</b>			
<b>SOLAR</b>			
BEASLEY	160 litre 300 litre		PRE 1982 MODELS
RHEEM	160 litre 300 litre		
SOLAHART	180 lt } "L" and 300 lt } "K" series	180 litre } "J" 300 litre } series	180 litre } "J" 300 litre } series

NOTE: Length of anodes can be determined by its Part No., eg, ANR1210 is 1210 mm long.



### NEW to the STOKES Range -

### "Rod" and "Flexi Rod" Anodes to suit 50 litre units

Stokes Part No. ANR500 "Rod" type  
Stokes Part No. ANR500F "Flexi Rod" type

P.T.R. Valves

**Pressure and Temperature Relief Valves**

**HT55 Style 15mm (1/2") Pressure and Temperature Relief Valve**

Stokes Cat No.	Description
SHT501	Pressure Setting 500kPa
SHT503	Pressure Setting 700kPa
SHT505	Pressure Setting 850kPa
SHT507	Pressure Setting 1000kPa
SHT511	Pressure Setting 1400kPa

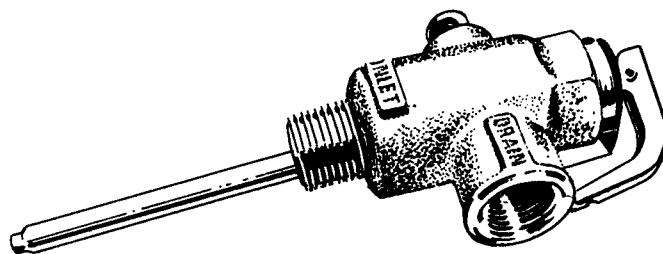

HT55 Pressure and Temperature Relief Valve

**Valve with 1" Extension**

**HTE55-1 Style 15mm (1/2") Pressure and Temperature Relief Valve**

Stokes Cat No.	Description
SHTE501	Pressure Setting 700kPa
SHTE502	Pressure Setting 850kPa
SHTE504	Pressure Setting 1000kPa
SHTE506	Pressure Setting 1400kPa

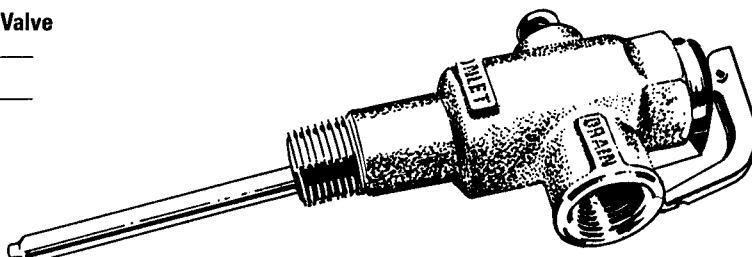

HTE55-1 Pressure and Temperature Relief Valve with 1" extension on body inlet

**Valve with Integrated Outlet**

**HTT55-1 Style 15mm (1/2") Pressure and Temperature Relief Valve**

Stokes Cat No.	Description
SHTT502	Pressure Setting 700kPa
SHTT503	Pressure Setting 850kPa
SHTT505	Pressure Setting 1000kPa
SHTT507	Pressure Setting 1400kPa

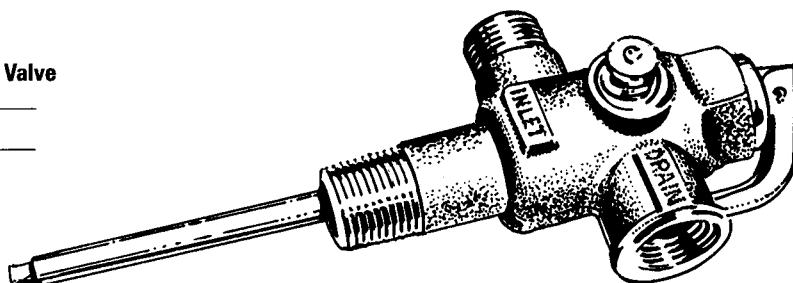

HTT55-1 Pressure and Temperature Relief Valve with integrated outlet and 1" extension on body inlet

**OTHER VALVES AVAILABLE ON REQUEST**

**SEE APPLICATION GUIDE ON NEXT PAGE**

## P.T.R. Valves

# VALVE TYPE APPLICATION GUIDE

### AQUAMAX

Model	Valve Type Reference No.	Pressure
<b>Natural Gas</b> Adjustable (135-200L)	HT55	1400kPa
<b>LP Gas</b> Adjustable (135-200L)	HT55	1400kPa

### BEASLEY

Model	Valve Type Reference No.	Pressure
<b>Electric</b> 160L, 180L, 250L	HT55	700kPa
300L, 315L, 440L, 600L	HT55	700kPa

### EDWARDS

Model	Valve Type Reference No.	Pressure
Solar 180L	HT55	850kPa
Solar 305L	HT55	850kPa
Solar 440L	HT55	850kPa
Solar 600L	HT575	850kPa
Gas 300L	2 x HT575	850kPa
Gas 350L	2 x HT575	850kPa
Electric 250L	HT55	850kPa
Electric 300L	2 x HT575	850kPa
Electric 315L	HT55	850kPa
Electric 350L	2 x HT575	850kPa

### HARDIE DUX

Model	Valve Type Reference No.	Pressure
Gas 90L	HTT55-1	1400kPa
Gas 105L	HT55	1400kPa
Gas 135L	HTT55-1	1400kPa
Gas 145L	HT55	1400kPa
Gas 170L	HTT55-1	1400kPa
Gas 185L	HT55	1400kPa
<b>Electric</b> 25L, 50L, 80L, 125L, 160L	HT55	1400kPa
Electric 250-315L	HT55	850kPa
Electric 400L	HT55	850kPa
Titan 400L	HT575	850kPa

### HOCKING

Model	Valve Type Reference No.	Pressure
<b>Electric</b> 21L, 25L, 31L, 40L, 50L	HT55	1000kPa
<b>Electric</b> 80L, 125L, 160L	HT55	1400kPa
Electric 250L-315L	HT55	1000kPa
Multi Element	HT575	1000kPa

### RHEEM

Model	Valve Type Reference No.	Pressure
Gas 90L	HT55	1400kPa
Gas 135L	HT55	1400kPa
Gas 170L	HT55	1400kPa
Gas 200L	HT55	1000kPa
Gas 260L	HTE575-1	1000kPa
Gas 265L	HTE575-1	1000kPa
Gas 275L	HTE575-1	1000kPa
Electric 25L	HT55	1400kPa
Electric 50L	HT55	1400kPa
Electric 80L	HT55	1400kPa
Electric 125L	HT55	1400kPa
Electric 160L	HT55	1400kPa
Electric 250L	HT55	1000kPa
Electric 315L	HT55	1000kPa
Electric 400L	HT55	1000kPa
Heavy Duty Electric 50L	HTE575-1	1000kPa
Heavy Duty Electric 315L	HTE575-1	1000kPa

### SAXON/TRUFLOW

Model	Valve Type Reference No.	Pressure
<b>Electric</b> 90L, 140L, 180L, 250L	HPNR R	1400kPa

### VULCAN

Model	Valve Type Reference No.	Pressure
Gas Freeloaders	HTT55-1	1400kPa
Gas Hoshot	HT55	1400kPa
<b>Electric</b> 50L, 80L, 125L, 160L	HT55	1400kPa
250L, 315L, 400L	HT55	1000kPa

ALL VALVES LISTED ARE AS PER WATER HEATER MANUFACTURERS SPECIFICATIONS AT TIME OF PRINTING. MANUFACTURERS RESERVE THE RIGHT TO MODIFY DESIGNS AND SPECIFICATIONS AND WITHDRAW AND INTRODUCE PRODUCTS. CONTACT THE WATER HEATER MANUFACTURER FOR ANY CLARIFICATION.

Elements – Urns

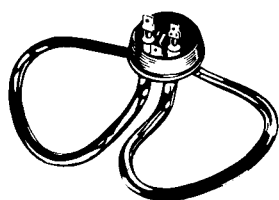

**Cat No.**  
2582-A 1500W  
2166-A 1800W  
2580-A 2400W  
To suit Kambrook, Hecla,  
Astro and Sarena urns  
**Cat No. 6044**  
T.O.D. mounted in head

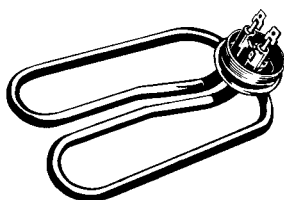

**Cat No.**  
2107 1500W  
2108 2400W  
To suit Hecla and  
Jomack urns and  
Dim Sim Warmers  
**Cat No. 6044**  
T.O.D. mounted in head

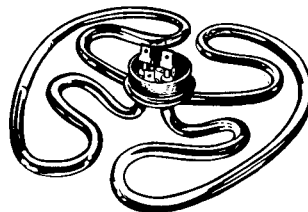

**Cat No.**  
3550 2400W  
To suit Langco/Zip  
UASSC/1, UASSC/2,  
UASSC/4, UASSC/6 urns  
**Cat No. 6044**  
T.O.D. mounted in head

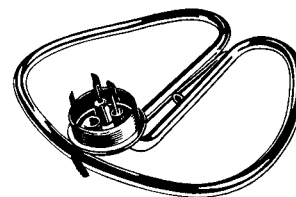

**Cat No.**  
HW1095 2400W  
To suit Sarena urns  
Hole in head for capillary  
access

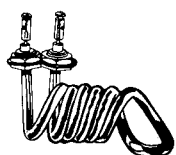

**Cat No.**  
SUH15 1500W  
To suit Hecla UL6, UL8,  
UL10 urns



**Cat No.**  
SLA15 1500W  
To suit Langco UA56 urns

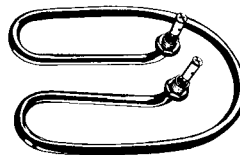

**Cat No.**  
SFV6A 1800W  
To suit Fowlers Vacola



**Cat No.**  
SU12 1200W  
To suit Westgate MU1, MU2,  
MU4, MU6 urns and Servex  
G12, G12M urns

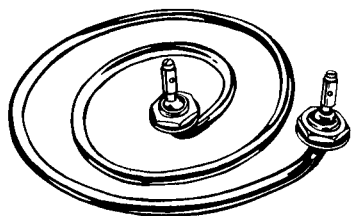

**Cat No.**  
SWBF30 1500W  
SWBF40 2000W  
SWBF46 2400W  
To suit Birko 51A, 62A, urns  
(anticlockwise)

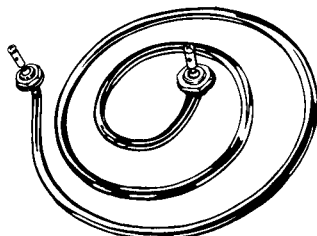

**Cat No.**  
SWB46 2400W  
To suit Westgate U28,  
U30, U32  
Spade Terminals  
(clockwise)



**Cat No.**  
SU9 1500W  
To suit Servex G9, G10  
urns and Westgate MU3,  
U22, U24, U25, U26,  
CU2, CU6 urns and  
Hecla UIOST urns



**Cat No.**  
SUI0A 750W  
To suit Servex G10A,  
G10M urns and  
Westgate U1, U16,  
MU5 urns

**\*MOST ABOVE ELEMENTS NOW SUPPLIED WITH SPADE TERMINALS**

**EQUIVALENTS LIST**

LN Products	Stokes
FV6A	SFV6A
LA15	SLA15
UH15	SUH15
UKM15	2107
UKM24	2108
UK15	2582-A
UK24	2580-A
UK24L	3550
UK24S	HW1095
U9	SU9
U10A	SU10A
U12	SU12
WBF30	SWBF30
WBF40	SWBF40
WBF46	SWBF46
WB46	SWB46

Email Grimwood	Stokes
FL900002	2580-A
412	SWB46
904	SU9
906	SU10A
907	SU12
4053	SDI-1
4108	SG3



## Elements – Kettles/Jugs

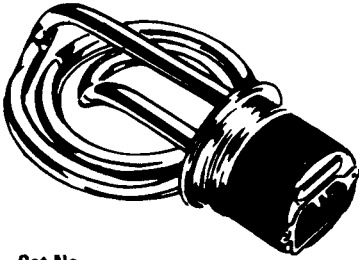

**Cat No.**  
**3451-A 1800W**  
**3452-A 2000W**  
**3453-A 2400W**

General purpose element to suit most kettles and metal jugs with 40-42mm openings.  
 Originally fitted to Kambrook kettles.  
 Euro plug

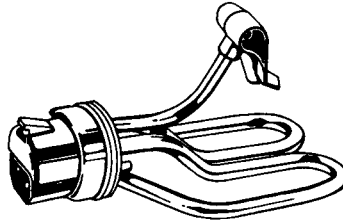

**Cat No.**  
**SKES24E 2400W**  
 Steamstat element to suit Langco, Kambrook, Birko and Everest kettles.  
 Euro plug

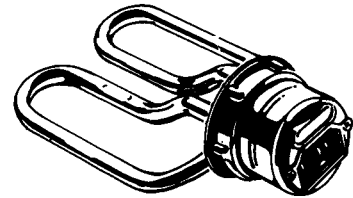

**Cat No.**  
**SKHE18 1800W**  
**SKHE24 2400W**  
 To suit Kenwood A128, Hecla 7/7, Langco K7/7 and many imported kettles including Swan, Wellco, Best, Hoover, Pifco, Sapphire, Tower, Sona, Hotpoint, Premier.  
 Euro plug

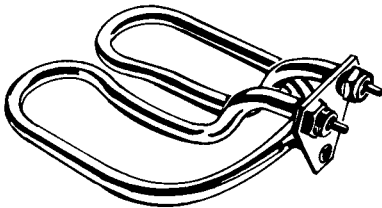

**Cat No.**  
**SKLC18 1800W**  
 To suit Langco Kettlematic kettles – short terminal ends (11mm)

**Cat No.**  
**SKRH24 2400W**  
 To suit Russell Hobbs K1 and K2 kettles – long terminal ends (16mm)

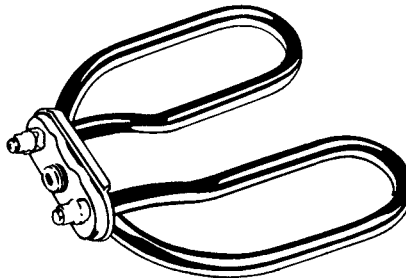

**Cat No.**  
**9401 2400W**  
 To suit Russell Hobbs K3 kettles

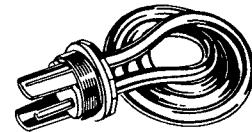

**Cat No.**  
**SKB15 1600W**  
 To suit most metal jugs including Zip, Hermetic, Eutron, BNB, Monash, Chevron, Staychrome, Ultimate, Supreme, Modurn and Huntingdon

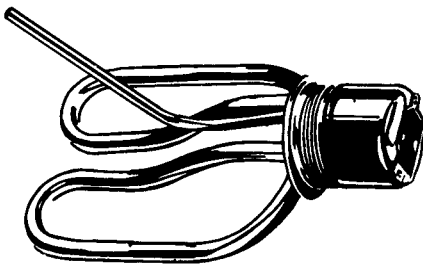

**Cat No.**  
**2158 2400W**  
 Steamstat to suit Speedie, Goldair and Neilsen kettles.  
 Euro plug

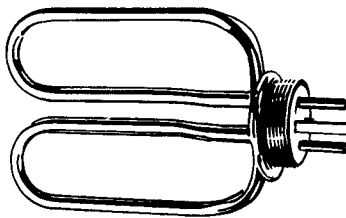

**Cat No.**  
**1905 2000W**  
 General purpose element  
 Ashley plug

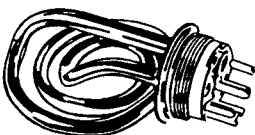

**Cat No.**  
**9402 2000W**  
 General purpose jug element to suit Breville and many other brands

## EQUIVALENTS LIST

LN Products	Stokes
KES24E	SKES24E
KHA24	1905
KHE18	3451-A
KHE18	SKHE18
KHE24	3453-A
KHE24	SKHE24
KLC18	SKLC18
KRH24	SKRH24
KRH24B	9401

LN Product	Stokes
KB15	SKB15
ZY132	DE
ZY132B	J1
ZY132C	J2
ZY132D	J3
ZY132E	HP

Elements – Kettles/Jugs

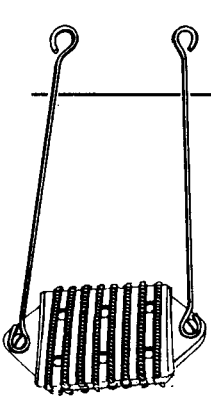

**Cat No. J1 1600W**  
Standard jug element  
Long arm (140mm)

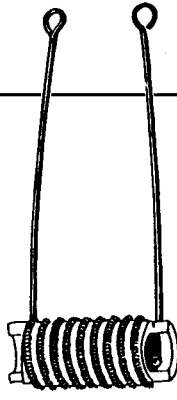

**Cat No. J3 1600W**  
Robust jug element  
Long arm (150mm)

**Cat No. J2 1250W**  
Standard jug element  
Short arm (110mm)

**Cat No. J4 1250W**  
Robust jug element  
Short arm (110mm)

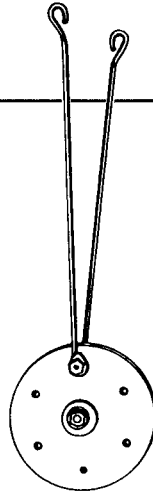

**Cat No. DE**  
Disc element for hard water areas. Care may be needed in determining the mineral content of water as too high mineral content will cause excessive power drag eg, South Australian water conditions

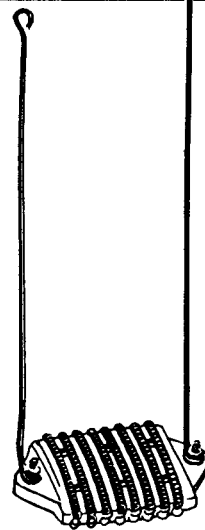

**Cat No. JA2 1600W**  
Speedie automatic jug element  
Long arm (150mm)

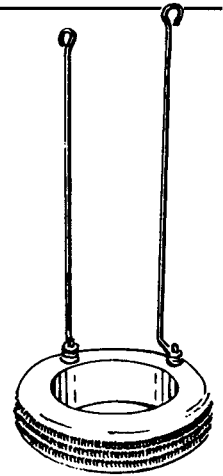

**Cat No. HP 1600W**  
Hotpoint automatic jug element  
Arm length (150mm)

**Cat No. JA3 1250W**  
Speedie automatic jug element  
Short arm (110mm)

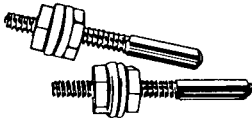

**Cat No. JP**  
Jug pins  
(pack of 2)



**Cat No. 2150-03**  
Locking ring to suit standard kettle and urn element heads (in packs of 5)  
Thread diameter 1 9/16" 16 T.P.I. Whitworth

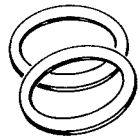

White Silicon rubber gasket for kettles and urns



**Cat No. JS 1600W**  
Jug spiral

**Cat No. 2450-11**  
Outside diam.: 48mm  
Inside diam.: 38.55mm  
Thickness 1.5-2mm

**Cat No. 2152-11**  
Outside diam.: 48.5mm  
Inside diam.: 38.55mm  
Thickness 4mm

**RETRACT-O-CORD Safety Appliance Lead**

1 metre .75mm<sup>2</sup> coiled flex with three pin plug and a selection of appliance sockets

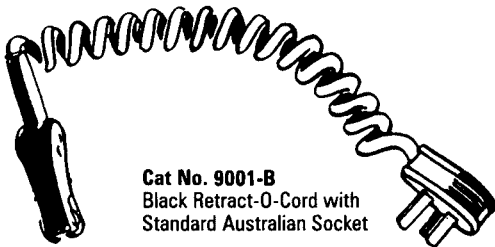

**Cat No. 9001-B**  
Black Retract-O-Cord with Standard Australian Socket



**Cat No. 9002-B**  
Black Retract-O-Cord with Ashley Socket

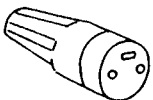

**Cat No. 9003-B**  
Black Retract-O-Cord with Euro. Standard Socket

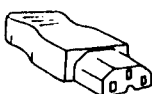

**Cat No. 9003-W**  
White Retract-O-Cord with Euro. Standard Socket

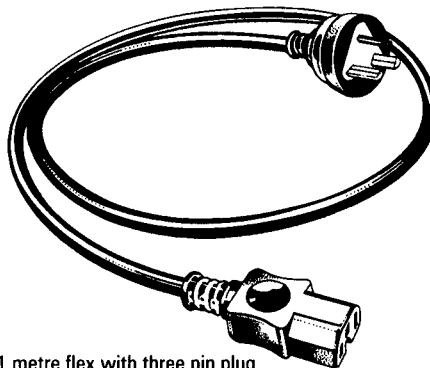

1 metre flex with three pin plug and Euro standard socket fitted (hot condition)

**Cat No. 9004-B** – Black lead and plugs  
**Cat No. 9004-W** – White lead and plugs

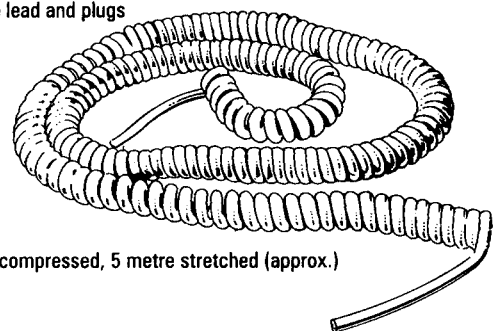

Retract-O-Cord lengths  
3 core 10 amp 1.5 metre compressed, 5 metre stretched (approx.)  
**Cat No. 9000B** – Black  
**Cat No. 9000W** – White

## Elements – Coffee Machines

---



**Cat No.**  
**SHS24 2400W**  
2" B.S.P. to suit Haros  
drink dispenser

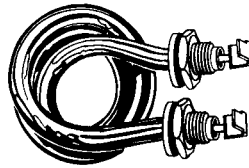

**Cat No.**  
**SCB24 2400W**  
To suit Cafe Bar old style  
junior model

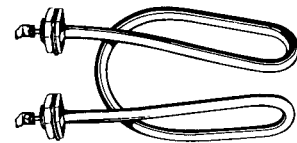

**Cat No.**  
**SCB24A 2400W**  
To suit Cafe Bar new style  
junior model

**Other types of coffee machine elements available on request (Cafe Bar and La Scottys)**

---

## Elements – Portable Immersion Elements

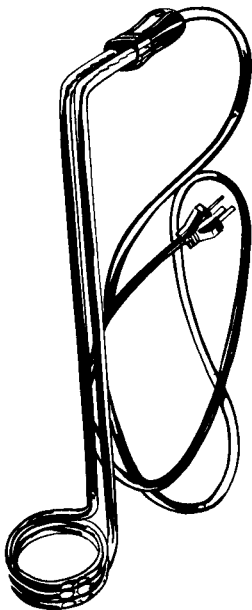

**Cat No.**  
**SG3 2400W**  
Complete with 1.8m flex and plug  
Height: 420mm 240 volt



**Cat No.**  
**SDI-1 1250W**  
With socket to suit Australian  
standard appliance plug  
Height: 240mm 240 volt

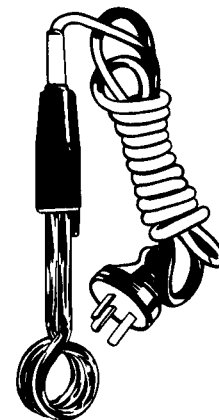

**Cat No.**  
**9355 395W**  
Cup heater for travellers  
Complete with 900mm flex and plug  
Height: 150mm 240 volt

**Elements – Bain Marie**

**BEND IT YOURSELF**

Straight length elements with 3/8" B.S.P. brazed brass bushes, locking nut and gasket for waterproof fit. Can be bent to suit required heat patterns.

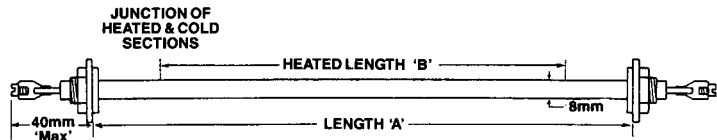

**Wet Bain Maries**

Corrosion Resistant Incoloy 800 Sheath (46.5kW/m<sup>2</sup>)

Cat No.	Wattage	Length "A" (mm)	Heated Length "B" (mm)
2201-10B	500	455	345
2202-10B	750	675	560
2203-10B	1000	875	760
2204-10B	1250	1095	985
2205-10B	1500	1295	1185
2206-10B	1800	1555	1445
2207-10B	2000	1735	1620
2208-10B	2500	2155	2050
2209-10B	3000	2575	2470

**Wet/Dry Bain Maries**

Corrosion Resistant Incoloy 800 Sheath (31kW/m<sup>2</sup>)

Cat No.	Wattage	Length "A" (mm)	Heated Length "B" (mm)
2211-10B	500	675	560
2212-10B	750	995	880
2213-10B	1000	1295	1185
2214-10B	1250	1635	1530
2215-10B	1500	1935	1830
2216-10B	1800	2315	2215
2217-10B	2000	2575	2470
2218-10B	2500	3215	3115

**Thermostats and Controls**

**Cat No. TYJ6333**  
15A control  
Knob: Cat No. TYJK  
**Cat No. TP-105**  
15A control  
Knob: Cat No. 105K

**Cat No. 7406**  
16A thermostat  
Temp. range: 30-120°C  
Capillary length: 830mm  
Bulb length: 98 x 6mm  
(E.G.O. No. 55.13022.310)  
Knob: Cat No. 7406K

**Cat No. EA5-607-00**  
25A thermostat  
Temp. range: 15-120°C  
Capillary length: 1830mm  
Bulb length: 115 x 10mm  
Knob: Cat No. P2662

**Cat No. 7009-A**  
20A thermostat kit  
includes knob and bezel  
Temp. range: 30-110°C  
Capillary length: 830mm  
Bulb length: 115 x 6mm

**BENDING INSTRUCTIONS**

Stokes Bain Marie Elements can easily be bent to shape on site.

1. Measure the dimensions of the required configuration and mark on the element.
2. Locate the junction of the heated and cold sections of the element eg. Cat No. 2204-10B  
1095 mm (Length "A")  
– 985 mm (Length "B")  
110 mm (Total cold length)  
÷ 2  
55 mm (Cold length of each end)
3. Ensure this junction is a minimum of 6mm from the bend.

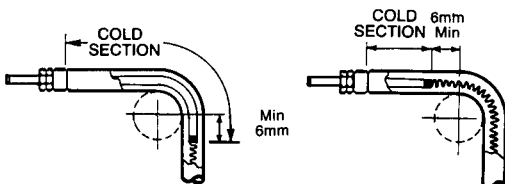

4. Bend elements around any smooth, round surface eg. pipe or madrel

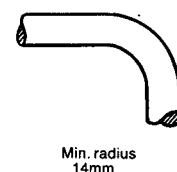
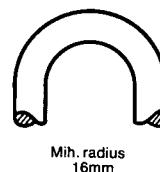

5. Start bending from the centre of the element and work outwards taking care that sharp edges of tools or clamps do not damage the element sheath.
6. To bend the terminal ends, use a section of pipe of slightly larger diameter than the element. A minimum straight section of 25mm should be left at the end.

## Triple immersion elements

2" B.S.P. screw in immersion heaters with a triple element assembly for greater flexibility in industrial applications.

### Oil and Alkaline Solution Heating Corrosion Resistant Incoloy 800 Sheath

Cat No.	Wattage	Watts Density (kW/m <sup>2</sup> )	Penetration Length (mm)
2620	1500	31	364
2621	2250	31	523
2622	3000	31	675
2623	3750	31	847
2624	4500	31	997
2625	5400	31	1189
2626	6000	31	1320
2627	7500	31	1640

### Water Heating Corrosion Resistant Incoloy 800 Sheath

Cat No.	Wattage	Watts Density (kW/m <sup>2</sup> )	Penetration Length (mm)
2630	1800	77.5	221
2631	2700	77.5	297
2632	3600	77.5	372
2633	4500	77.5	447
2634	5400	77.5	522
2635	6000	77.5	574
2636	7200	77.5	675
2637	9000	77.5	827
2638	10.8kW	77.5	974
2639	14.4kW	77.5	1282
2640	1800	116	144
2641	2700	116	195
2642	3600	116	246
2643	4500	116	296
2644	5400	116	346
2645	6000	116	380
2646	7200	116	448
2647	9000	116	553
2648	10.8kW	116	643
2649	14.4kW	116	845

### Accessories

Cat No.	Description
2620-09	P.V.C. terminal cover
TE/7	0-80°C 20A thermostat
TE/D	0-100°C 20A thermostat
2221-22	2" B.S.P. brass lock nut

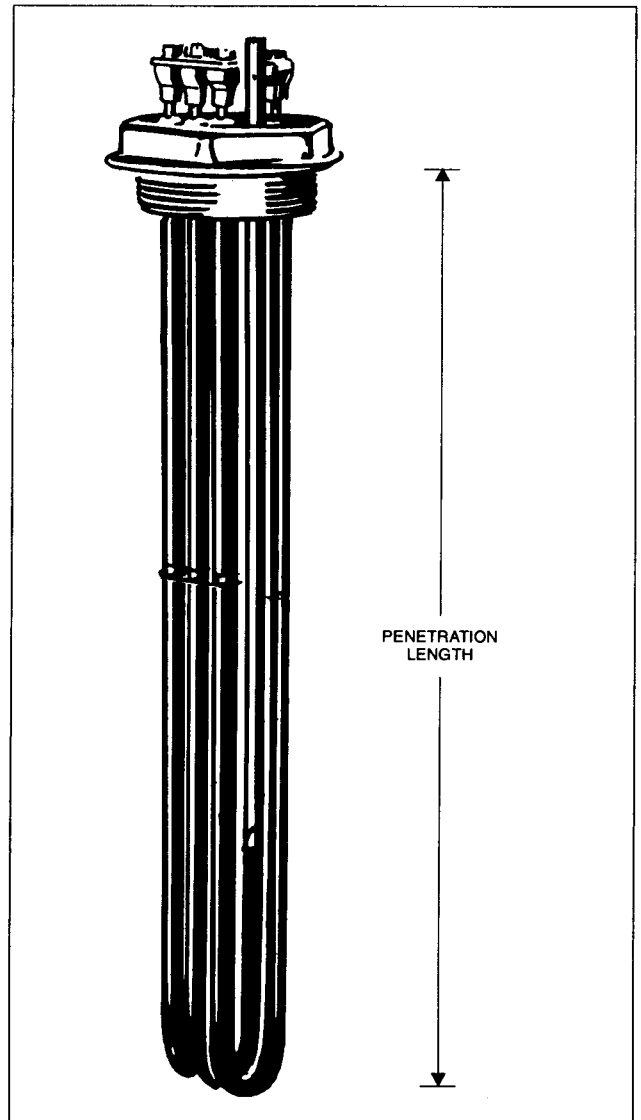

### ELECTRICAL CONNECTIONS TRIPLE IMMERSION HEATERS

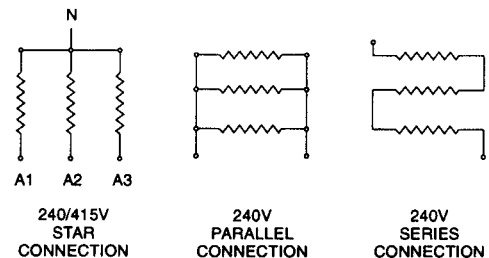

### FORMULA TO CALCULATE SERIES WATTAGE

$$3 \times \text{ELEMENTS} - \frac{\text{RATED WATTS}}{9} = \text{NEW TOTAL WATTS}$$

$$2 \times \text{ELEMENTS} - \frac{\text{RATED WATTS}}{4} = \text{NEW TOTAL WATTS}$$

Hot Water Urns

---



Catalogue No.

**HW5T**  
**HW10T**  
**HW20T**  
**HW30T**

Description

**5 Litre Urn**  
**10 Litre Urn**  
**20 Litre Urn**  
**30 Litre Urn**

*Please turn over for more information and parts*

---

## Hot Water Urns

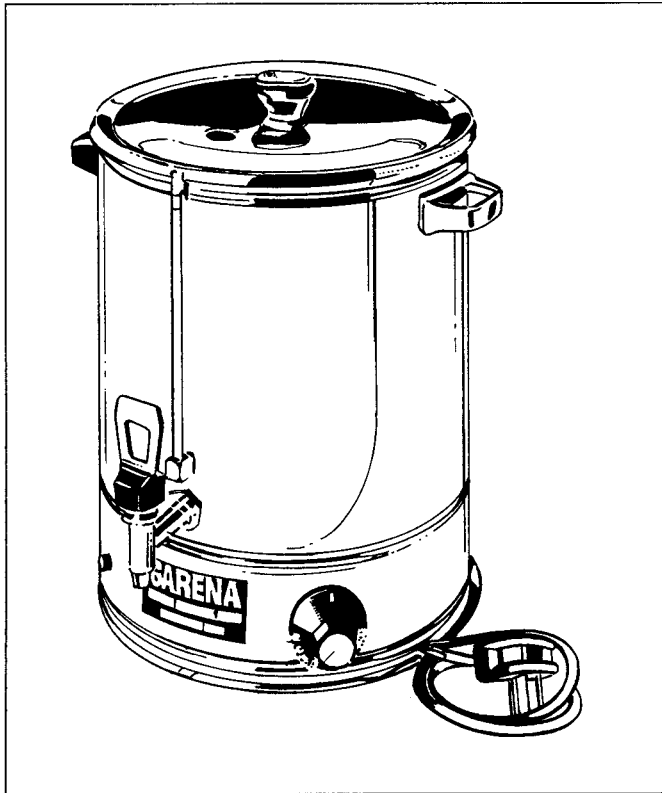

- **Welded Stainless Steel Construction**
- **Complete with Flex and Plug**
- **Pilot Light**
- **Gauge Glass**
- **Thermostatically Controlled**
- **Non-drip Tap**
- **Polished Stainless Steel Body and Lid**
- **Side Handles for Easy Carrying**
- **12 Month Guarantee**

## Spare Parts Available Ex Stock

Catalogue No.	Description
2580-A	2400W Element with boil dry protection for previous models using a "Simmerstat" control
HW1095	2400W Element for current models – HW5T, HW10T, HW20T, HW30T
TYJ6333	Simmerstat for previous models (replaces Cat Nos. T3-203, T1-203, TYJ02B)
TYJK	Knob for Simmerstat TYJ6333
7406	30-120°C Thermostat (current model urns with gland)
7406K	Knob for 7406
HW1026	Tap Assembly including nut
HW1100	Urn Tap Seal Kit
HW1015	Gauge Glass
HW1055	Urn Cleaner
HW1017	Urn Side Handle
A29	Pilot Light (Red) 0.3 watt

Hot Water System

---

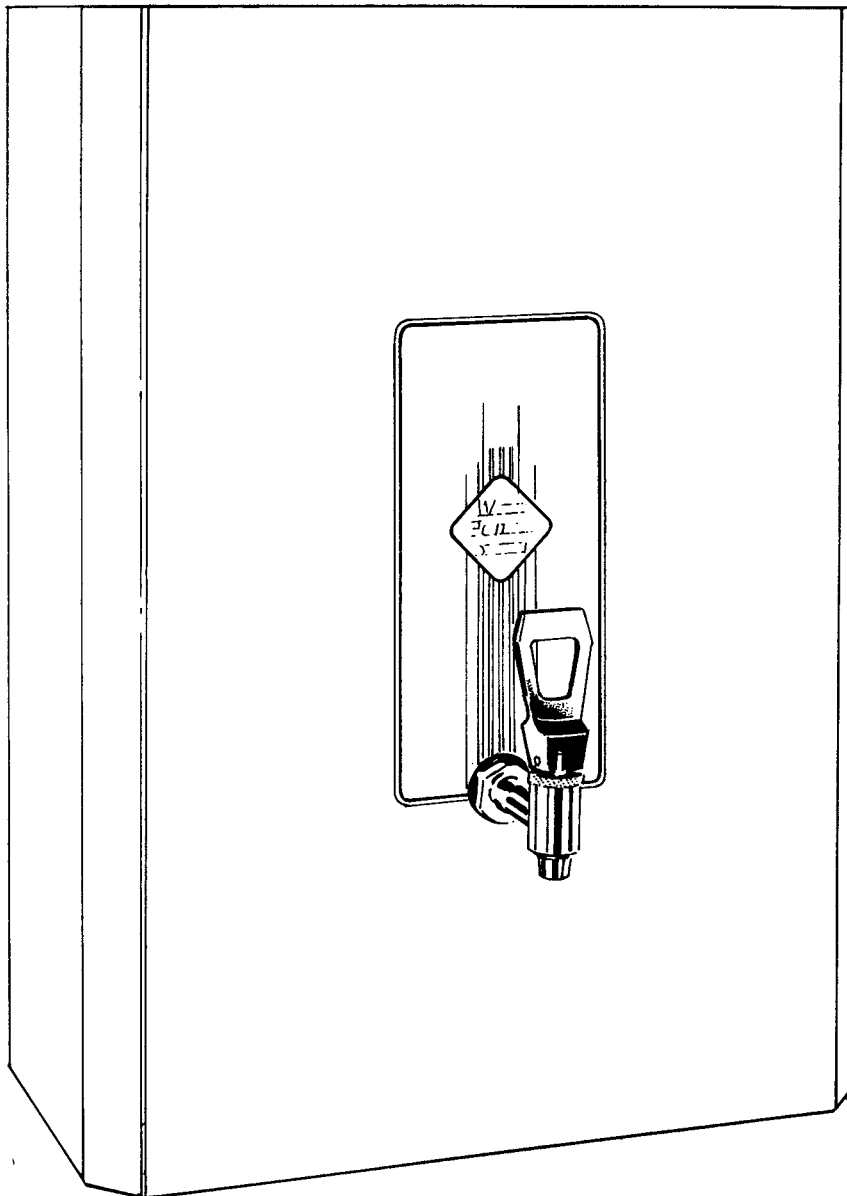

**Home, Office, Factories, Schools, Hospitals, Clubs, Restaurants**

- **Boiling Water Instantly**
  - **Automatic and Steam Free**
  - **Fast Recovery**
  - **Made in Australia**
  - **Low Running Costs**
  - **Stainless Steel Exterior**
  - **Stainless Steel Tank**
  - **Patented Design**
- **Water Boiling Systems work on continuous supply of water**  
*(plumbing may be necessary)*



## Hot Water System

---

### Water Boiling System

- Gives Boiling Water Instantly
- Fills Automatically with Fast Recovery • Steam Free
- Low Running Costs • Easily Installed • 12 Months Guarantee
- Fully Insulated Stainless Steel Tank for Long Life
- Metal Non-Drip Tap

<b>Model No. Sarena</b>	<b>Sarena 2.5</b>	<b>Sarena 5</b>	<b>Sarena 10</b>	<b>Sarena 15</b>
Storage Capacity	2.5 Litres	5 Litres	10 Litres	15 Litres
Initial Draw Off (cups)	15	30	60	100
Initial Draw Off (litres)	2.5	5	10	15
First Hour Delivery (cups)	125 approx.	135 approx.	175 approx.	200 approx.
Cups Recovery Per Hour	125 approx.	125 approx.	125 approx.	125 approx.
Electrical Heating Element	2.4 Kw	2.4 Kw	2.4 Kw	2.4 Kw
Supply Voltage	220/240v	220/240v	220/240v	220/240v
Min. Supply Pressure	2 Bar	2 Bar	2 Bar	2 Bar
Max. Supply Pressure	10 Bar	10 Bar	10 Bar	10 Bar
Electrical Wiring Supplied	3 Pin Plug	3 Pin Plug	3 Pin Plug	3 Pin Plug
Approx. Weight	6kg	7kg	9kg	10kg
Overall Height (A)	430mm	510mm	565mm	565mm
Width (B)	315mm	365mm	425mm	425mm
Depth (C)	210mm	240mm	310mm	310mm
Depth (D)	125mm	170mm	240mm	240mm
Tap Height (E)	185mm	160mm	160mm	160mm

*\*A Water Filter is necessary for hard water, scale and high sediment water areas.*